

N-117
N-119



LCD Drawer & KVM Benefits

- ▶ Multi-user Matrix KVM with either 16 or 32 ports in 1U
- ▶ Cost efficient Combo KVM integration
- ▶ "One Man" installation slides for easy, quick installation
- ▶ Mix PS/2, USB & SUN with Multi-Platform switch capability
- ▶ Secure remote user access across the world wide web

Drawer Features & Options

- 1U rackmount drawer with either 17" or 19" LCD
- Combo interface either PS/2 or USB input to the LCD drawer
- Multiple keyboard language selections with either touchpad or trackball
- Slide rails with fixed positions to prevent drawer movement when typing
- An aesthetically enhanced latching front panel to release the two point lock

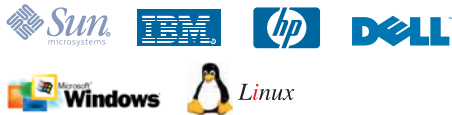

Options page 103~104 for full details



S-Video + BNC



DC Power

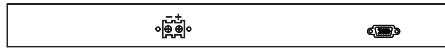

DVI-D



Audio



Diagram
Unit : mm

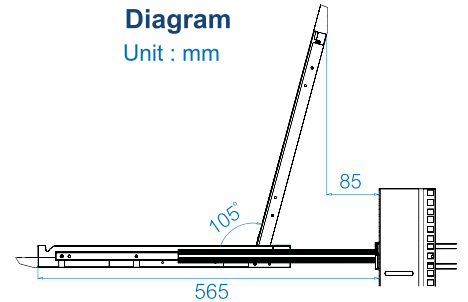

Monitor  Grade A 17" or 19" industrial TFT LCD panel page 105 for full monitor details

Dimensions

Model	Product Dimension (W x D x H)	Packing Dimension (W x D x H)	Net Weight	Gross Weight
N-117 Series	442 x 650 x 44 mm 17.4 x 25.6 x 1.73 inch	589 x 856 x 168 mm 23.2 x 33.7 x 6.6 inch	16 kg / 35 lbs	22 kg / 48 lbs
N-119 Series	442 x 650 x 44 mm 17.4 x 25.6 x 1.73 inch	589 x 856 x 168 mm 23.2 x 33.7 x 6.6 inch	17 kg / 37 lbs	23 kg / 51 lbs

Keyboard Selection

Supporting layouts



Ne N keyboard integrated with touchpad

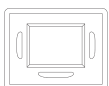
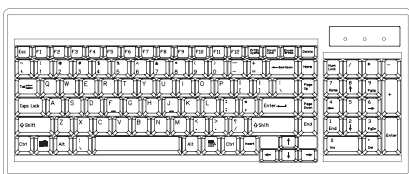

Nb N keyboard integrated with trackball

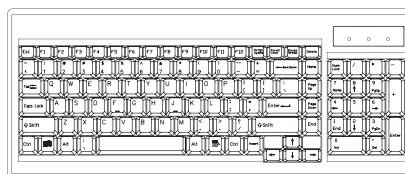

page 106 for full keyboard details

back

















KVM Selection















Base Model	17" LCD Series	19" LCD Series
<ul style="list-style-type: none"> * Single port w/o KVM * Combo interface 	N-117	N-119

Matrix Cat6 KVM









page 23~38 for KVM specifications, page 107~110 for KVM rear I/O

	2 consoles	Matrix Cat6 16 port	N117 - MU 1602	N119 - MU 1602
	3 consoles		N117 - MU 1603	N119 - MU 1603
	4 consoles		N117 - MU 1604	N119 - MU 1604
	3 consoles	Matrix  Cat6 16 port	N117 - MU IP 1613	N119 - MU IP 1613
	4 consoles		N117 - MU IP 1614	N119 - MU IP 1614
	4 consoles		N117 - MU IP 1624	N119 - MU IP 1624
	2 consoles	Matrix Cat6 32 port	N117 - MU 3202	N119 - MU 3202
	3 consoles		N117 - MU 3203	N119 - MU 3203
	4 consoles		N117 - MU 3204	N119 - MU 3204
	3 consoles	Matrix  Cat6 32 port	N117 - MU IP 3213	N119 - MU IP 3213
	4 consoles		N117 - MU IP 3214	N119 - MU IP 3214
	4 consoles		N117 - MU IP 3224	N119 - MU IP 3224







Matrix DB-15 KVM

	2 consoles	Matrix DB-15 8 port	N117 - M 802	N119 - M 802
	3 consoles		N117 - M 803	N119 - M 803
	4 consoles		N117 - M 804	N119 - M 804
	3 consoles	Matrix  DB-15 8 port	N117 - M IP 813	N119 - M IP 813
	4 consoles		N117 - M IP 814	N119 - M IP 814
	4 consoles		N117 - M IP 824	N119 - M IP 824
	2 consoles	Matrix DB-15 16 port	N117 - M 1602	N119 - M 1602
	3 consoles		N117 - M 1603	N119 - M 1603
	4 consoles		N117 - M 1604	N119 - M 1604
	3 consoles	Matrix  DB-15 16 port	N117 - M IP 1613	N119 - M IP 1613
	4 consoles		N117 - M IP 1614	N119 - M IP 1614
	4 consoles		N117 - M IP 1624	N119 - M IP 1624



Combo Cat6 KVM

	1 console	Combo Cat6 8 port	N117 - U 801	N119 - U 801
	2 consoles		N117 - U 802	N119 - U 802
	2 consoles		N117 - U IP 802	N119 - U IP 802
	1 console	Combo Cat6 16 port	N117 - U 1601	N119 - U 1601
	2 consoles		N117 - U 1602	N119 - U 1602
	2 consoles		N117 - U IP 1602	N119 - U IP 1602
	1 console	Combo Cat6 32 port	N117 - U 3201	N119 - U 3201
	2 consoles		N117 - U 3202	N119 - U 3202
	2 consoles		N117 - U IP 3202	N119 - U IP 3202

Combo DB-15 KVM

	1 console	Combo DB-15 8 port	N117 - S 801	N119 - S 801
	2 consoles		N117 - 802	N119 - 802
	2 consoles		N117 - IP 802	N119 - IP 802
	1 console	Combo DB-15 16 port	N117 - S 1601	N119 - S 1601
	2 consoles		N117 - 1602	N119 - 1602
	2 consoles		N117 - IP 1602	N119 - IP 1602

PS/2 DB-15 KVM

	1 console	 DB-15 8 port 16 port	N117 - 801	N119 - 801
			N117 - 1601	N119 - 1601